



**NEW MEXICO MEASURES
OF STUDENT SUCCESS AND
ACHIEVEMENT**



NM-MSSA

Mathematics

Grade 6 • Practice Test



**PLACE STUDENT
LABEL HERE**



Copyright © 2021 by New Mexico Public Education Department
All rights reserved. No part of this publication may be reproduced or transmitted in any form or by any means, electronic or mechanical,
including photocopy, recording, or any information storage and retrieval system, without permission in writing from the copyright owner.
Portions of this work were previously published. Printed in the United States of America.

Mathematics Session 1

DIRECTIONS

Today you will take a test in mathematics. For this test, you will answer selected-response and constructed-response questions. Some of the questions may look different from test questions you have seen before, and some may ask about material that is new to you, but it is important to do your best. If you are not sure of the answer to a question, you should still try to answer it.

You may NOT use a calculator to answer the questions in this session.

1. The owner of a restaurant buys sets of tables and chairs. She buys 6 chairs for each table.

Which equation shows the relationship between t , the number of tables, and c , the number of chairs?

- A $t = 6c$
- B $c = 6t$
- C $t = c + 6$
- D $c = t + 6$

SESSION

1



2. Lucy traced each face of a three-dimensional shape. The faces she traced are shown.

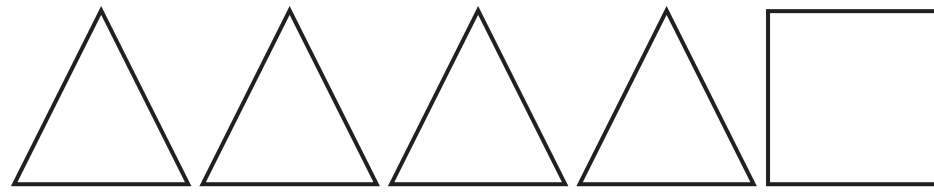

Which three-dimensional shape did Lucy trace?

A

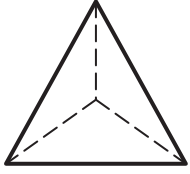

B

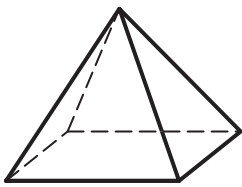

C

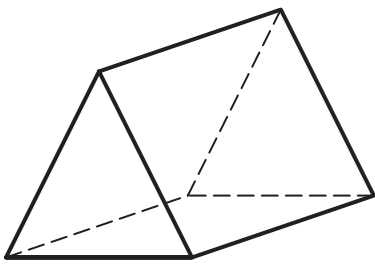

D

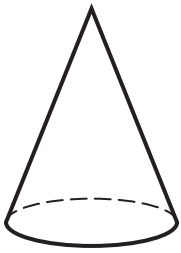

SESSION

1

3. Mr. Brown asked Susan to write a statistical question. This is the question Susan wrote.

How many children does Mr. Brown have? |

Did Susan write a statistical question?

- A** Yes, because the answer is a number.
- B** No, because the question is written for only one person to answer.
- C** Yes, because there will be variability in the data collected from this question.
- D** No, because there will be no variability in the data collected from this question.
4. Jerry is thinking of two rational numbers, r and s , such that r is located to the right of s on a number line. Jerry made these claims about r and s :
- Claim 1: $r > s$
 - Claim 2: $|r| > |s|$

Which statement **best** describes Jerry's claims?

- A** Only Claim 1 is true for all rational numbers.
- B** Only Claim 2 is true for all rational numbers.
- C** Both Claim 1 and Claim 2 are true for all rational numbers.
- D** Neither Claim 1 nor Claim 2 is true for all rational numbers.
5. Ben has d dollars. Sally has 3 dollars less than Ben.

Which expression represents the amount of money that Sally has?

- A** $d+3$
- B** $3-d$
- C** $d-3$
- D** $3d$

6. The number of customer calls received by a call center is shown in this table.

Call Center

Time (p.m.)	Number of Calls
1 to 2	50
2 to 3	68
3 to 4	48
4 to 5	35
5 to 6	60
6 to 7	48
7 to 8	20

Which graph **best** represents the data in the table?

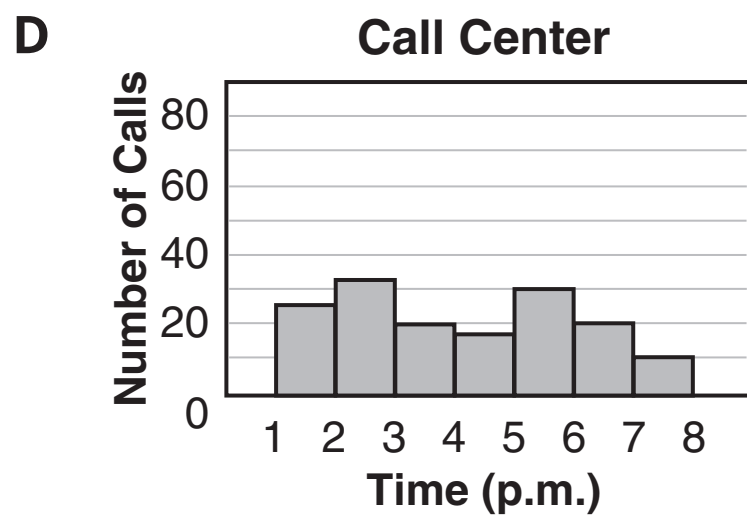
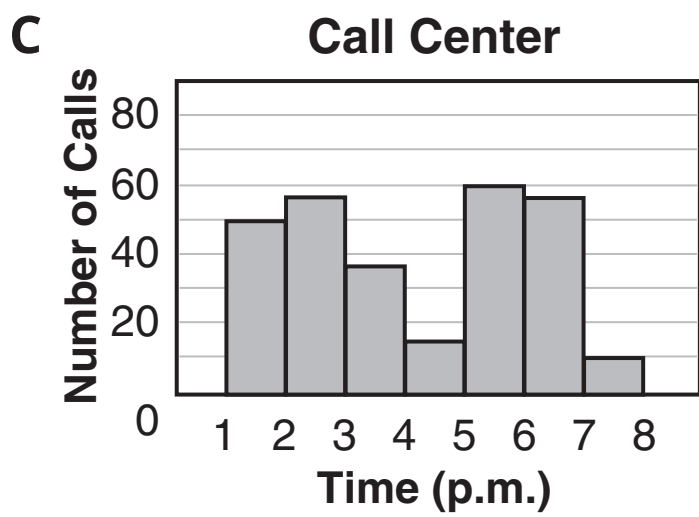
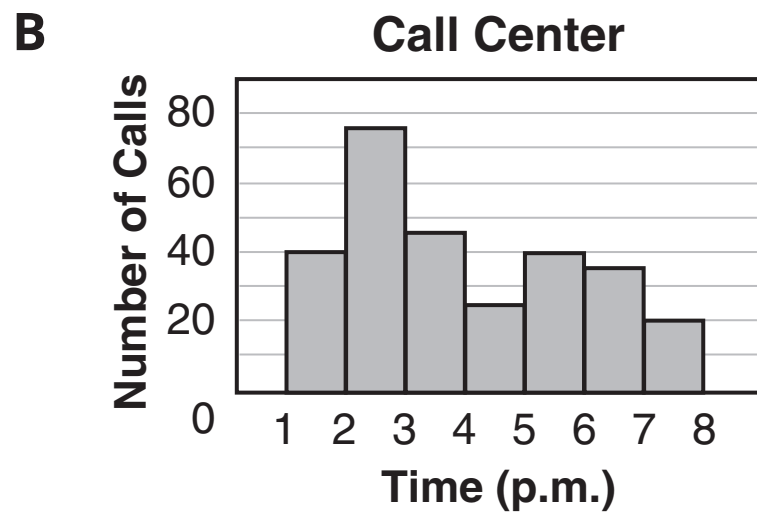
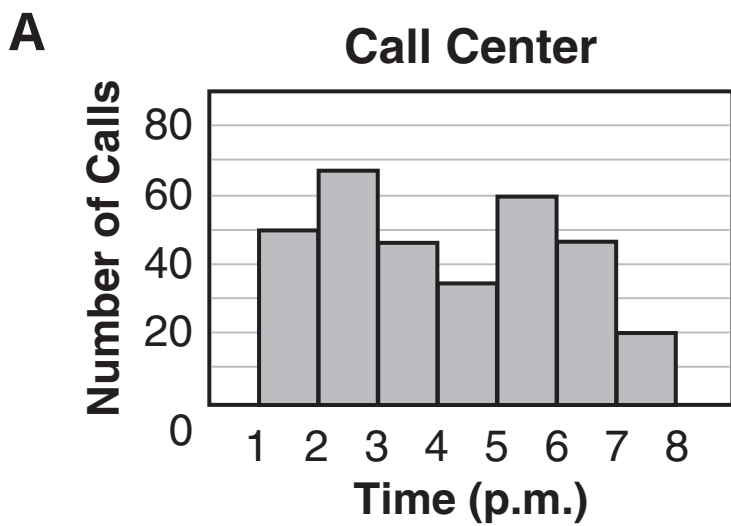

SESSION
1

7. The table shows the relationship between the time in hours and the distance in miles that a train is traveling.

Time in Hours (t)	Distance in Miles (d)
2	150
4	300
6	450
8	600

Based on the table, which equation represents the relationship between the distance, d , and time, t ?

- A $d = 75 + t$
- B $d = 75t$
- C $d = 150 + t$
- D $d = 150t$

This question has four parts. Be sure to answer all parts of the question.

- 8.** The table shows the prices of some camping gear Jan is buying.

Camping Gear Prices

Item	Price (in dollars)
Sleeping bag	\$59.95
Tent	\$89.75
Rope	\$0.79 per foot
Hand warmers	\$2.19 each

- Jan buys a sleeping bag and some rope from a 100-foot roll. Write an expression, using a variable, to model his total cost. Explain what the variable represents.
- There are 100 hand warmers available at the store. Write an expression, using a different variable, to model the cost of buying some hand warmers. Explain what this variable represents.
- Describe the possible values for each of the variables you used.
- Are there any possible values for one variable that are not possible for the other variable? Use words or numbers to explain your answer.

9. Vertex P of triangle MNP is located 2 units directly below vertex N on this coordinate plane.

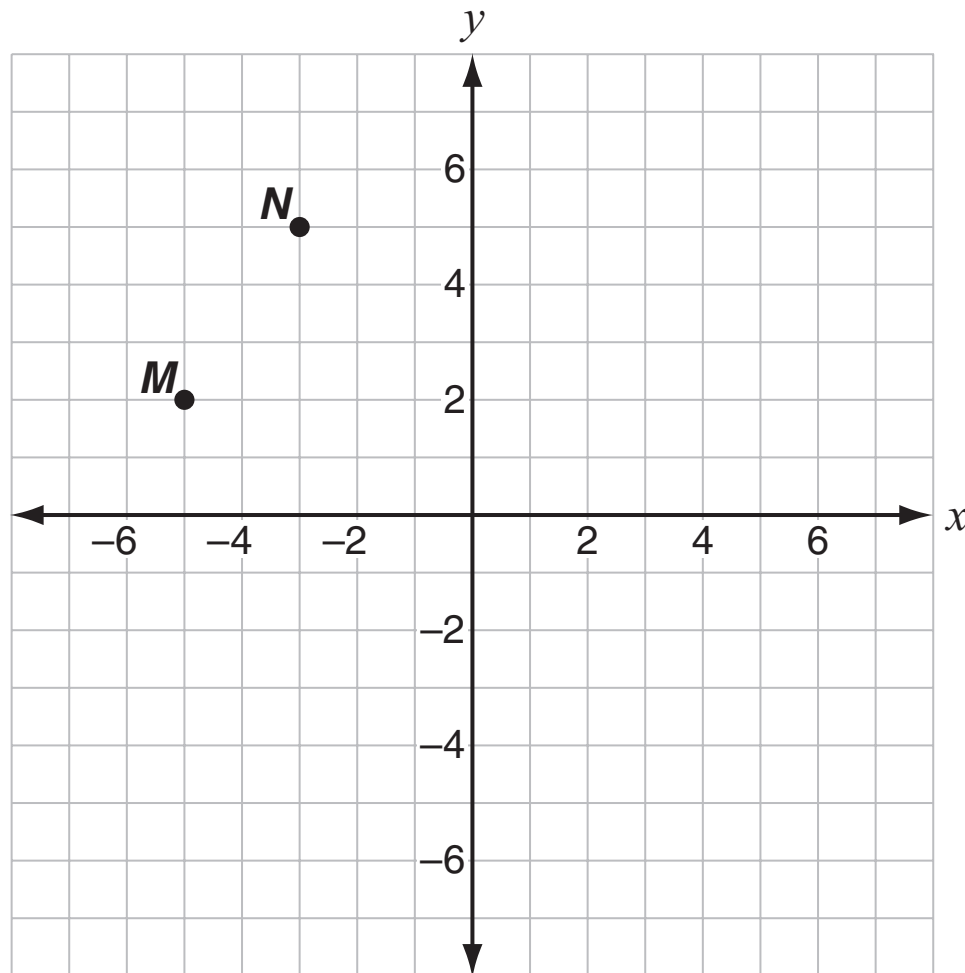

What are the coordinates of vertex P ?

- A $(-5, 3)$
B $(3, -5)$
C $(3, -3)$
D $(-3, 3)$
10. The perimeter of a rectangle is represented by this expression:

$$2(3x + 8 + 2x)$$

Which expression also represents the perimeter of the rectangle?

- A $8x + 8$
B $5x + 10$
C $9x + 16$
D $10x + 16$

11. This right rectangular prism is packed with cubes.

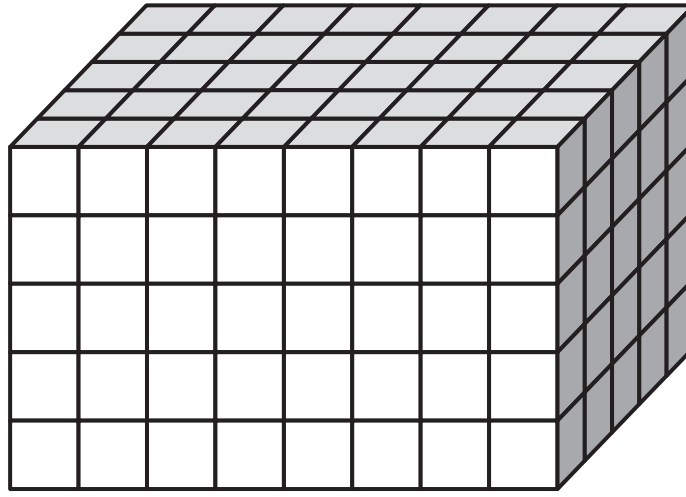

Each cube has a side length of $\frac{1}{10}$ meter.

Which expression can be used to find the volume, in cubic meters, of the prism?

A $8 \times 5 \times 5$

B $\frac{1}{10} \times \frac{1}{10} \times \frac{1}{10}$

C $\frac{8}{10} \times \frac{5}{10} \times \frac{5}{10}$

D $8 \times \frac{5}{10} \times \frac{5}{10}$

- 12.** This list shows data values increasing in order.

33, 40, 40, 40, 40, 51, ? , 62 , 71, ?

Two data values are missing.

Which measures can be determined from the data without the missing numbers?

- A** the mean and the range
 - B** the mode and the range
 - C** the median and the mean
 - D** the median and the mode
- 13.** Rashaun surveyed 17 students to determine how often they ate cafeteria food for lunch during the last two weeks. He made this line plot to show the results.

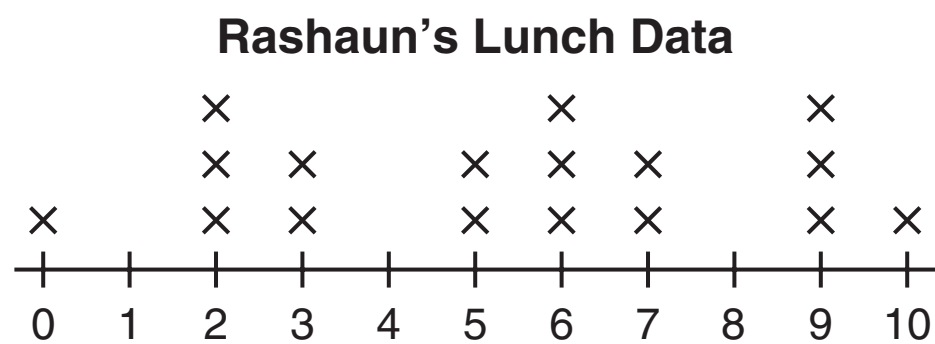

Which would be the **best** label for Rashaun to use on the number line?

- A** Number of Cafeteria Lunches
- B** Number of Students
- C** Number of Weeks
- D** Number of Minutes in Lunch Line

This question has four parts. Be sure to answer all parts of the question.

- 14.** An elevator travels above the ground to different floors in a building. It also travels below the ground to different floors of a parking garage. The bottom of the elevator starts at ground level.

A vertical number line will be used to show the locations, in feet above and feet below ground level, to which the elevator travels. The number line ranges from 150 to -60 .

- What does the number 0 represent on the number line?
- What do the numbers 60 and -60 represent on the number line? Explain how you know.

Reese parked her car in the parking garage 30 feet below ground level. She takes the elevator up to a location 30 feet above ground level. Reese thinks that her car is farther from ground level than she is since her car is below the ground.

- Is Reese's thinking correct? Explain how you know.

The bottom of the elevator is now 45 feet from ground level. Gary thinks one number can be plotted on the number line to show this distance. Stephanie thinks two numbers can be plotted.

- Who is correct, Gary or Stephanie? Explain how you know. In your explanation, include the number or numbers that show this distance.

- 15.** Jasmine is painting her bedroom walls. The total area that needs to be painted is 480 square feet. Jasmine was able to paint 320 square feet in 4 hours.

How much longer will it take Jasmine to finish painting if she continues to paint at that same rate?

- 1 hour
- 2 hours
- 4 hours
- 6 hours

- 16.** Vivian's basketball team scored these numbers of points in the first five games of the season.

27, 31, 27, 22, 40

Her team scored 27 points in the sixth game and 35 points in the seventh game.

Which measure is affected by including these two scores with the scores of the first five games?

- A** mean
 - B** median
 - C** mode
 - D** range
- 17.** Which expression shows $48 + 34$ as the product of one factor **and** the sum of two whole numbers with no common factors other than 1?
- A** $2(24 + 17)$
 - B** $3(16 + 11)$
 - C** $4(12 + 8)$
 - D** $6(8 + 4)$

- 18.** Isabella has $\frac{7}{8}$ cup of barbecue sauce. She separates it into $\frac{1}{4}$ -cup portions.

How many portions of sauce does Isabella have?

- A** $\frac{7}{2}$
- B** $\frac{1}{6}$
- C** $\frac{7}{32}$
- D** $\frac{32}{7}$

19. Which expressions have a sum of 6.12? Select the **two** expressions.

- A** $3.6 + 3.6$
- B** $6.1 + 0.2$
- C** $2.42 + 3.7$
- D** $2.11 + 4.1$
- E** $5.02 + 1.1$

20. Which problem could be solved by dividing $\frac{2}{3}$ by $\frac{1}{6}$?

- A** Lillie cuts $\frac{2}{3}$ of a pie into pieces. Each piece is $\frac{1}{6}$ of the total pie. How many pieces of pie does Lillie have?
- B** Tucker cuts $\frac{2}{3}$ of a pizza into 6 slices. All the slices are the same size. What fraction of the whole pizza is each slice?
- C** Ethan has $\frac{2}{3}$ of a granola bar. He gives $\frac{1}{6}$ of the bar to his brother. How much of the granola bar does Ethan still have?
- D** Kaylinn has $\frac{2}{3}$ quart of milk. She pours $\frac{1}{6}$ of the milk into her cat's dish. What fraction of the milk does Kaylinn still have?





**DO NOT
TURN PAGE**

Mathematics Session 2

DIRECTIONS



Today you will take a test in mathematics. For this test, you will answer selected-response and constructed-response questions. Some of the questions may look different from test questions you have seen before, and some may ask about material that is new to you, but it is important to do your best. If you are not sure of the answer to a question, you should still try to answer it.

You **MAY** use a calculator to answer the questions in this session.

- 21.** The highest point in New Mexico is Wheeler Peak at an altitude of 13,161 feet. Which statement can be used to describe a , the altitude, in feet, of any other location in New Mexico?

- A** $a > 13,161$
- B** $a \geq 13,161$
- C** $a \leq 13,161$
- D** $a < 13,161$

- 22.** A school orders 720 calendars for a fundraiser. The total weight of the calendars is 390 pounds.

What is the approximate unit weight in ounces per calendar?

- A** 0.54 ounce per calendar
- B** 1.85 ounces per calendar
- C** 8.67 ounces per calendar
- D** 29.54 ounces per calendar



- 23.** The locations of Charlie's and Luke's houses are plotted on the grid below.

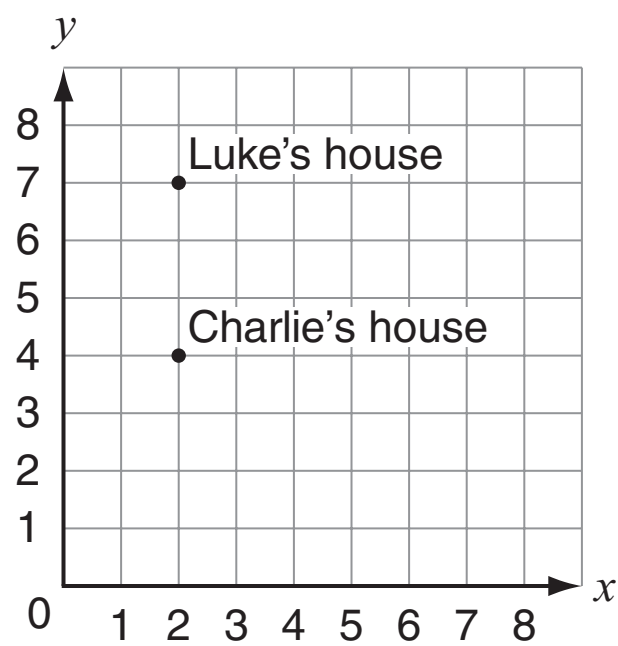

Which expression can be used to find the distance, in units, between Charlie's house and Luke's house?

- A** $|4 - 7|$
- B** $|2 - 7|$
- C** $|2 + 7|$
- D** $|4 + 7|$

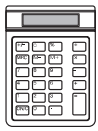

- 24.** A piece of wood with a length of $6\frac{1}{2}$ feet is cut into two smaller pieces. One of the smaller pieces has a length of $2\frac{1}{4}$ feet.

Which equation can be used to find x , the length, in feet, of the second smaller piece of wood?

- A** $2\frac{1}{4}x = 6\frac{1}{2}$
- B** $6\frac{1}{2}x = 2\frac{1}{4}$
- C** $x + 2\frac{1}{4} = 6\frac{1}{2}$
- D** $x - 6\frac{1}{2} = 2\frac{1}{4}$

- 25.** Points F , G , H , and I are plotted on this number line.

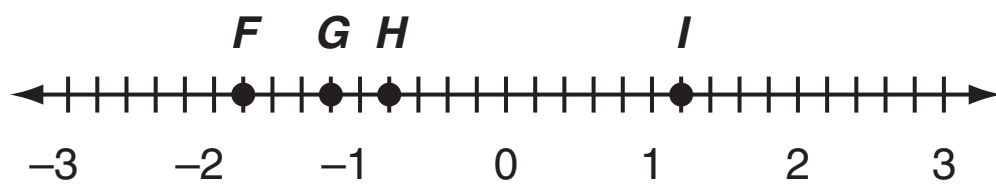

Which point represents -1.2 on the number line?

- A** point F
- B** point G
- C** point H
- D** point I



This question has two parts. Be sure to answer all parts of the question.

- 26.** Miranda makes this line plot to show the noon temperatures, in degrees Fahrenheit, during the past two weeks.

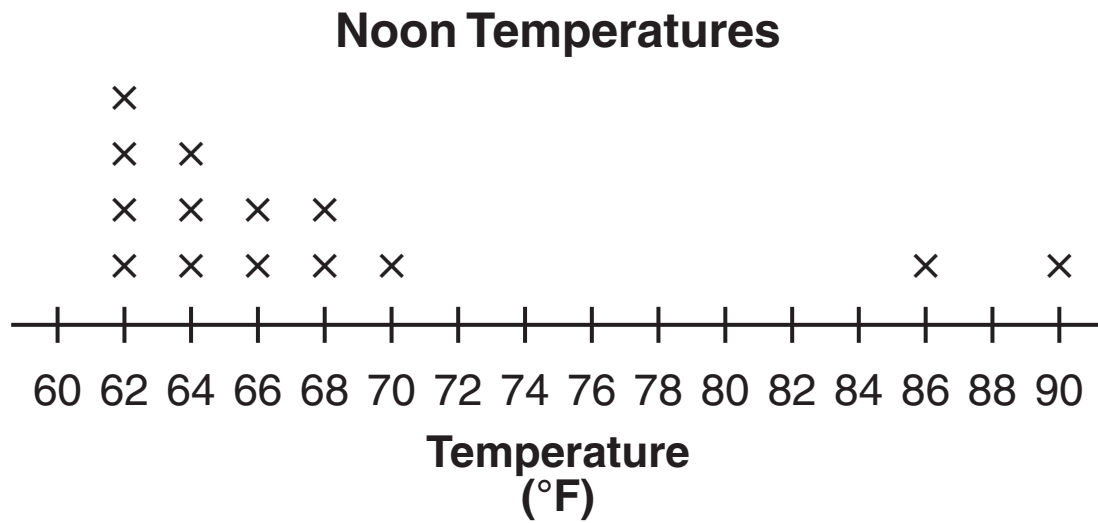

- What is the median of the data? Show your work or explain how you know.
 - Which measure of center, the mean or the median, best represents the data in the line plot? Use the shape of the data distribution to explain how you know.
- 27.** The dot plot shows the number of push-ups some students did during the push-up challenge at a school.

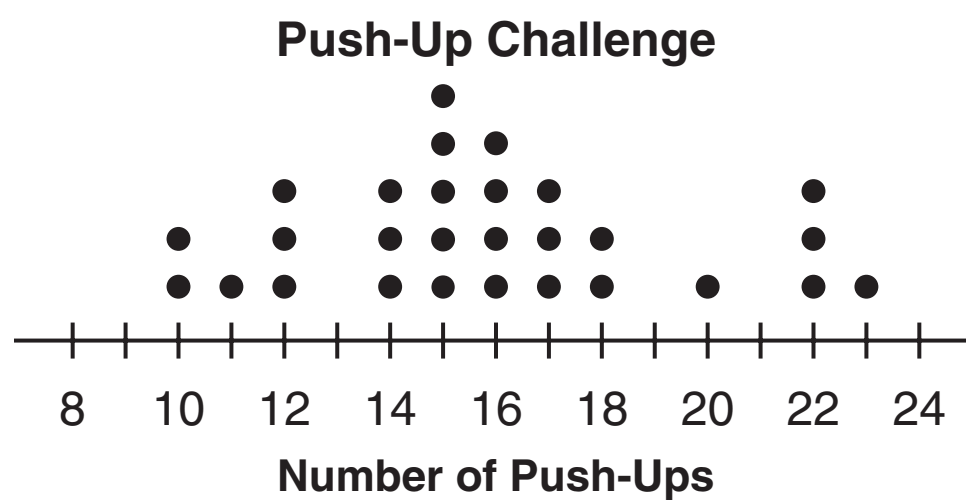

Based on the dot plot, which statement is true?

- Seven students did more than 18 push-ups.
- Half the students did more than 15 push-ups.
- Thirty students participated in the push-up challenge.
- Half the students did between 14 and 16 push-ups.

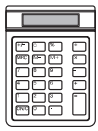

- 28.** A manager at a store sells bags of red apples and bags of green apples. These tables show the numbers of each type of apple in different numbers of bags.

Number of Bags	Number of Red Apples	Number of Bags	Number of Green Apples
3	24	2	18
6	48	4	36
9	72	8	72

Which statement **best** describes the ratio of red apples per bag to the ratio of green apples per bag?

- A** The ratios are the same because the greatest number of each type of apple is 72.
- B** The ratios cannot be compared because the numbers of bags and the numbers of apples are different.
- C** The ratio of red apples per bag is less than the ratio of green apples per bag because $\frac{24}{3}$ is less than $\frac{18}{2}$.
- D** The ratio of red apples per bag is greater than the ratio of green apples per bag because 24 is greater than 18.



Use the information below to answer questions 29 and 30.

Diego rode his bicycle 12.6 miles in 1.5 hours.

- 29.** Which equation shows the unit rate, r , in miles per hour, that Diego rode his bicycle?
- A** $1.5 \times 12.6 = r$
 - B** $1.5 \div 12.6 = r$
 - C** $12.6 + 1.5 = r$
 - D** $12.6 \div 1.5 = r$
- 30.** If Diego rides at the same average rate, how many miles will he ride in 2.5 hours?
- A** 15.1
 - B** 16.8
 - C** 21.0
 - D** 25.2

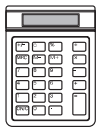

- 31.** This hexagon has six sides that are each approximately 2.3 units in length.

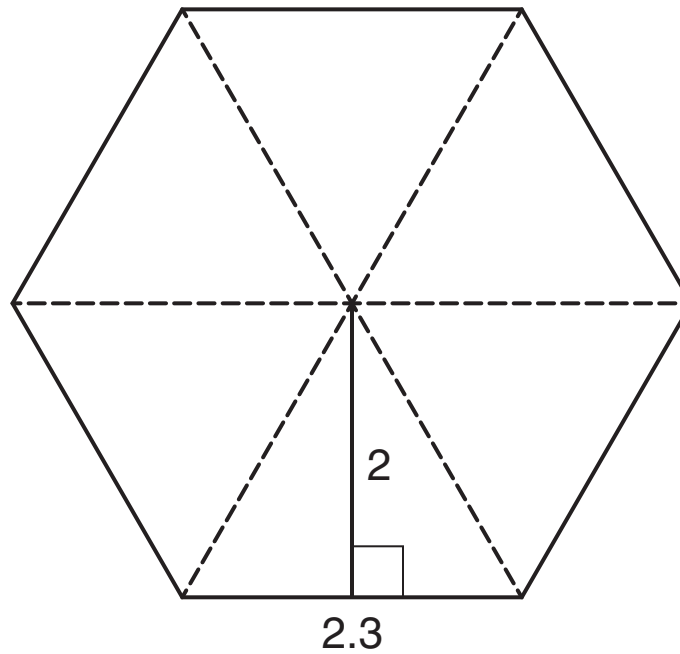

Which calculation shows the approximate area, in square units, of this hexagon?

- A** $6 \times \frac{1}{2}(2.3) \times \frac{1}{2}(2) = 6.9$
- B** $6 \times \frac{1}{2}(2.3 \times 2) = 13.8$
- C** $6 \times (2.3 + 2) = 25.8$
- D** $6 \times (2.3 \times 2) = 27.6$



32. A 15-ounce mixture of water and juice contains 3 ounces of water.

What is the ratio of water to juice?

- A** 1:6
- B** 1:5
- C** 1:4
- D** 1:3



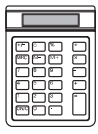

Use the information below to answer questions 33 and 34.

Mr. Nelson is shopping for fertilizer for his lawn. There are four brands of fertilizer that he is considering buying. Each brand of fertilizer is made up of different percentages by weight of nitrogen, phosphate, potash, and inert ingredients. The percentages for each brand of fertilizer are listed in this table, along with the size of the bag the fertilizer comes in, the area of lawn a bag of fertilizer will cover, and the price per bag.

Fertilizer Brand	Nitrogen (%)	Phosphate (%)	Potash (%)	Inert Ingredients (%)	Size of Bag (lb.)	Coverage Area (square feet)	Price (\$)
A	30	0	4	66	40	15,000	45.00
B	28	0	4	68	39	15,000	39.97
C	28	0	3	69	43	15,000	48.57
D	29	0	5	66	34	15,000	32.97

- 33.** Mr. Nelson wants to compare costs of the different brands of fertilizer. In one of his comparisons, he determines this ratio for each brand.

$$\frac{\text{price}}{(\text{size of bag})(\text{percent nitrogen})}$$

What will Mr. Nelson's ratio determine?

- A** percent nitrogen per square foot
- B** dollars per pounds of nitrogen
- C** percent nitrogen per dollar
- D** dollars per square foot



- 34.** Mr. Nelson wants to buy the brand of fertilizer that will provide the greatest amount of nitrogen per square foot of coverage area. Considering that one bag of each brand covers the same area, he chooses Brand A because it has the highest percentage of nitrogen. Did Mr. Nelson choose the brand that will provide the greatest amount of nitrogen per square foot?
- A** Yes, he was correct to choose the brand with the highest percentage of nitrogen.
 - B** No, he should have chosen Brand B because it has the lesser weight of the two brands with the lowest percentage of nitrogen.
 - C** No, he should have chosen Brand C because it has the greatest value of (size of bag)(percent nitrogen).
 - D** No, he should have chosen Brand D because it has the greatest value of $\frac{\text{size of bag}}{\text{percent nitrogen}}$.

- 35.** Cindy noticed that $\frac{8}{9}$ of the students in her math class were wearing jeans. A total of 24 students were wearing jeans.

Which equation can be used to find s , the total number of students in Cindy's math class?

- A** $\frac{s}{24} = \frac{8}{9}$
- B** $\frac{8}{9}s = 24$
- C** $24s = \frac{8}{9}$
- D** $s = \frac{8}{9} \times 24$



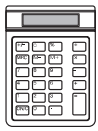

- 36.** Tyler's fish tank is shaped like a rectangular prism. The dimensions of the fish tank are shown.

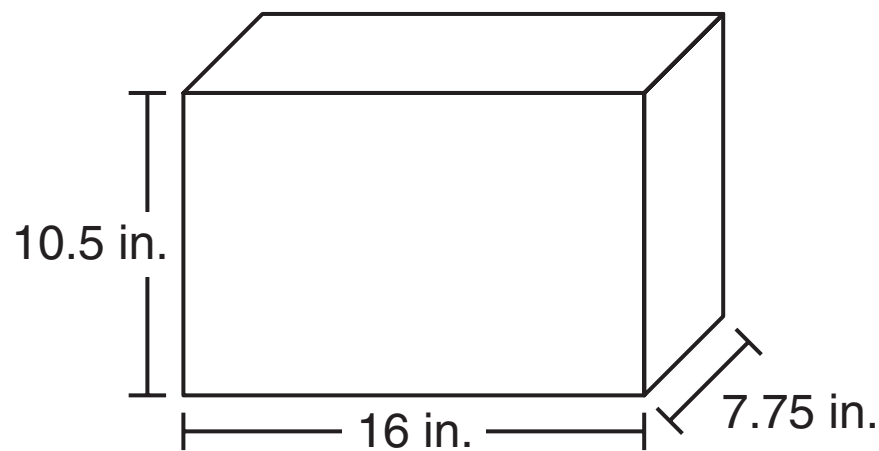

Tyler adds water to the tank until the surface of the water is 2 inches below the top of the tank.

What is the volume, in cubic inches, of the water in the tank?

- A** 966
- B** 1,054
- C** 1,302
- D** 2,604

This question has two parts. Be sure to answer all parts of the question.

SESSION
2

- 37.** On Jasper's farm, the ratio of cows to sheep is 4 : 1.

There are 120 cows on the farm.

- a. How many sheep are on the farm?
- b. What percent of the animals on the farm are sheep? Show your work or explain how you know.



38. Akeem describes the net of a triangular prism in this way:

“The net of a triangular prism has two square bases that are the same size and shape, and it has three triangular faces that connect the bases.”

Is Akeem’s description of the net of a triangular prism correct?

- A** yes, because triangular prisms have two bases and three faces
 - B** yes, because triangular prisms have square bases and triangular faces
 - C** no, because the net should have one triangular base and three triangular faces that meet at a single point at the top
 - D** no, because the net should have two triangular bases that are the same size and shape and three rectangular faces that connect the bases
- 39.** The shortest side of a triangle is x units long. The remaining two sides of the triangle are both 3 units longer than the shortest side.

Which expressions can be used to show the perimeter, in units, of the triangle? Select the **two** correct expressions.

- A** $3x+6$
- B** $3x+9$
- C** $3(x+3)$
- D** $x+x+x+3$
- E** $x+x+3+x+3$





40. Rectangular Prism W has dimensions of $6\frac{2}{5}$ inches, 6 inches, and $2\frac{1}{2}$ inches.

Which rectangular prism has a volume equal to the volume of the Rectangular Prism W ?

A

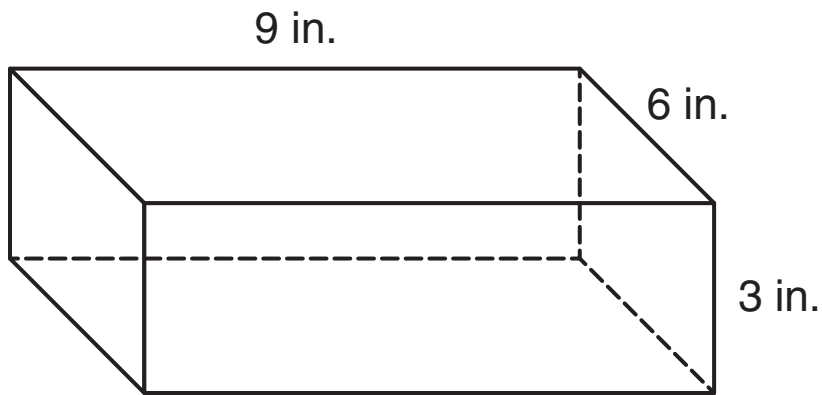

B

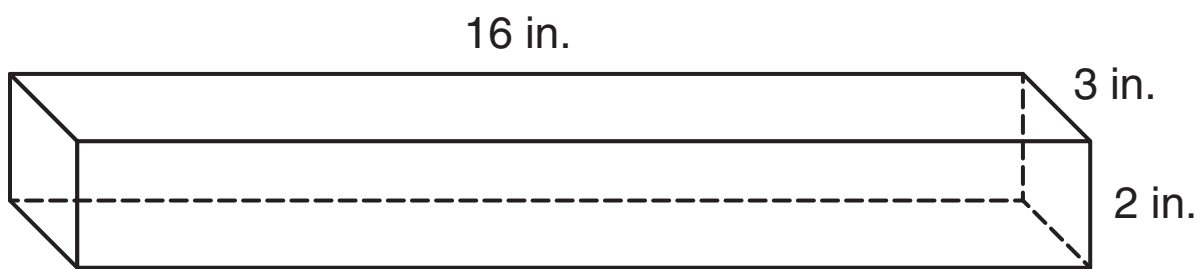

C

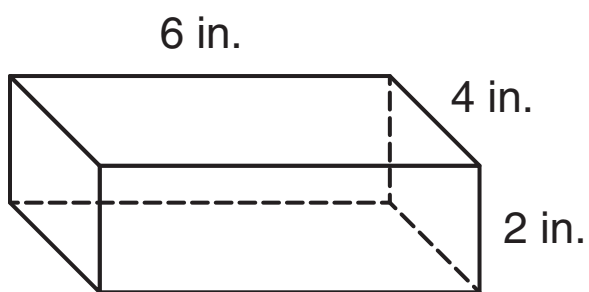

D

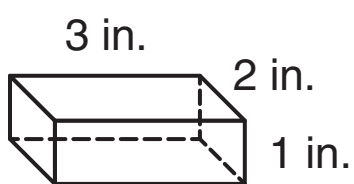



**DO NOT
TURN PAGE**



**NEW MEXICO MEASURES
OF STUDENT SUCCESS AND
ACHIEVEMENT**

16 Digit Static Barcode