



**NEW MEXICO MEASURES
OF STUDENT SUCCESS AND
ACHIEVEMENT**

M

S

S

A

NM-MSSA

Mathematics

Grade 8 · Practice Test



**PLACE STUDENT
LABEL HERE**



Copyright © 2021 by New Mexico Public Education Department
All rights reserved. No part of this publication may be reproduced or transmitted in any form or by any means, electronic or mechanical,
including photocopy, recording, or any information storage and retrieval system, without permission in writing from the copyright owner.
Portions of this work were previously published. Printed in the United States of America.

Mathematics Session 1

DIRECTIONS

Today you will take a test in mathematics. For this test, you will answer selected-response and constructed-response questions. Some of the questions may look different from test questions you have seen before, and some may ask about material that is new to you, but it is important to do your best. If you are not sure of the answer to a question, you should still try to answer it.

You may NOT use a calculator to answer the questions in this session.

1. Beginning in June 2004, Raphael noted the price of a stock at the same time twice each year. The graph shows the price of the stock during a three-year period.

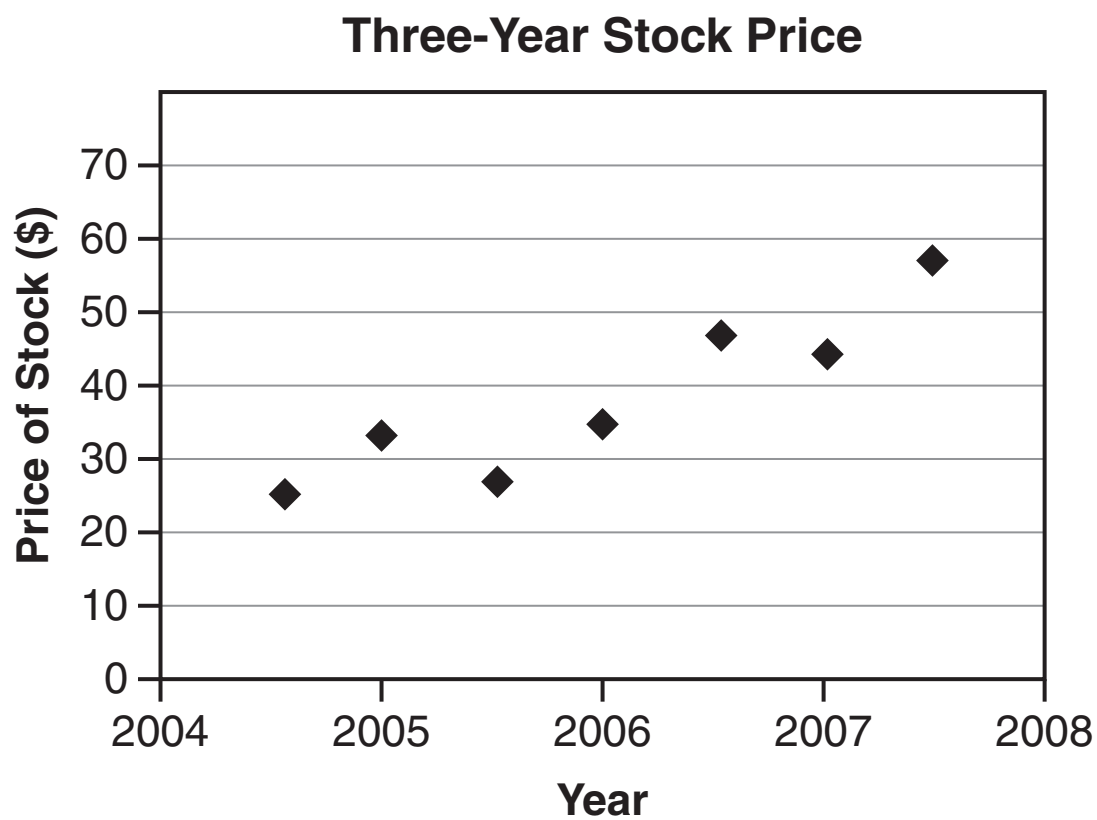

Which statement is true about the data?

- A The price was constantly increasing.
- B The price rose at least 10% every six months.
- C The price more than tripled during the three-year period.
- D The price more than doubled during the three-year period.

2. What fraction is equivalent to $0.\overline{27}$?

- A $\frac{2}{7}$
- B $\frac{3}{11}$
- C $\frac{1}{27}$
- D $\frac{27}{100}$

3. Miko will solve this equation for x in exactly two steps.

$$2(x+7) = 5$$

- Step 1: ?
- Step 2: ?

What is **most likely** the first step in Miko's solution?

- A Divide each side of the equation by 2.
- B Divide each side of the equation by 5.
- C Subtract 7 from each side of the equation.
- D Use the distributive property on the left side of the equation.

4. Triangle ABC is shown on this coordinate plane.

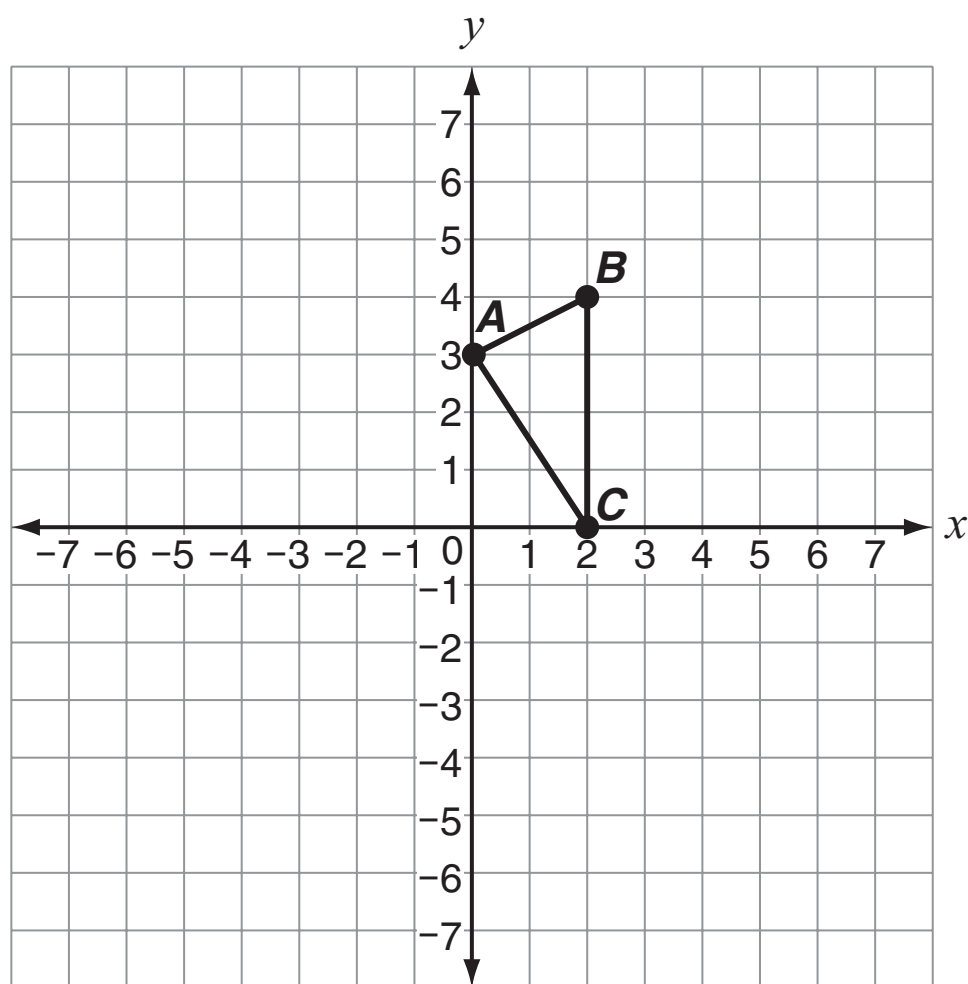

The triangle is dilated by a scale factor of 3 with point A as the center of dilation.

What are the coordinates of vertex B after the dilation?

- A $(5, 7)$
- B $(6, 6)$
- C $(6, 12)$
- D $(8, 7)$

5. The equation $w = 3.1t + 6$ can be used to estimate w , the weight of a puppy in ounces that is t weeks old.

Based on the equation, which statement compares the expected weight of a 1-week old puppy to the weight of a newborn puppy?

- A The 1-week old puppy weighs 3.1 ounces more.
B The 1-week old puppy weighs 3.1 ounces less.
C The 1-week old puppy weighs 6 ounces more.
D The 1-week old puppy weighs 6 ounces less.
6. Rory is looking at a table of x -values and y -values. Which process could Rory use to determine if y can be considered a function of x ?
- A make sure the x -values follow a pattern
B make sure the y -values follow a pattern
C make sure no two distinct x -values correspond to the same unique y -value
D make sure each unique x -value corresponds to exactly one unique y -value
7. Which inequalities are true? Select **all** that apply.
- A $\sqrt{5} > \sqrt{6}$
B $\sqrt{3+4} > 3$
C $\pi^2 > 9$
D $-6 > -2\pi$
E $\sqrt{22} > 5$

This question has two parts. Be sure to answer all parts of the question.

8. This scatterplot shows the number of bottles of water and the number of soft pretzels sold during different hours at a stadium snack stand.

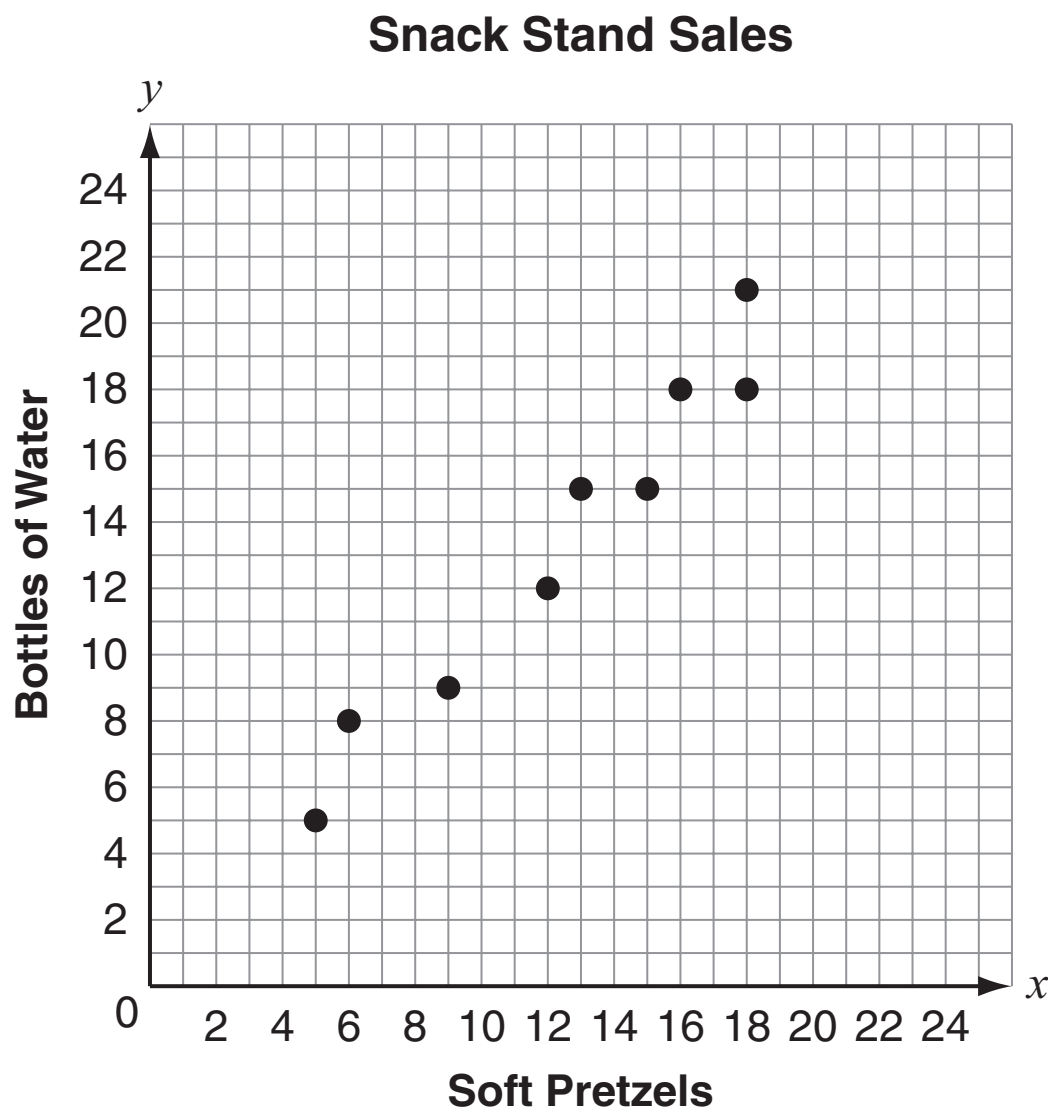

The equation $y = x + 0.5$ models the line of best fit, where x is the number of soft pretzels sold and y is the number of bottles of water sold.

- What does the slope of the model represent in this situation?
- Based on the line of best fit, how many bottles of water could be sold when 22 soft pretzels are sold? Show your work or explain how you know.

9. Triangle LMN is shown on this coordinate plane.

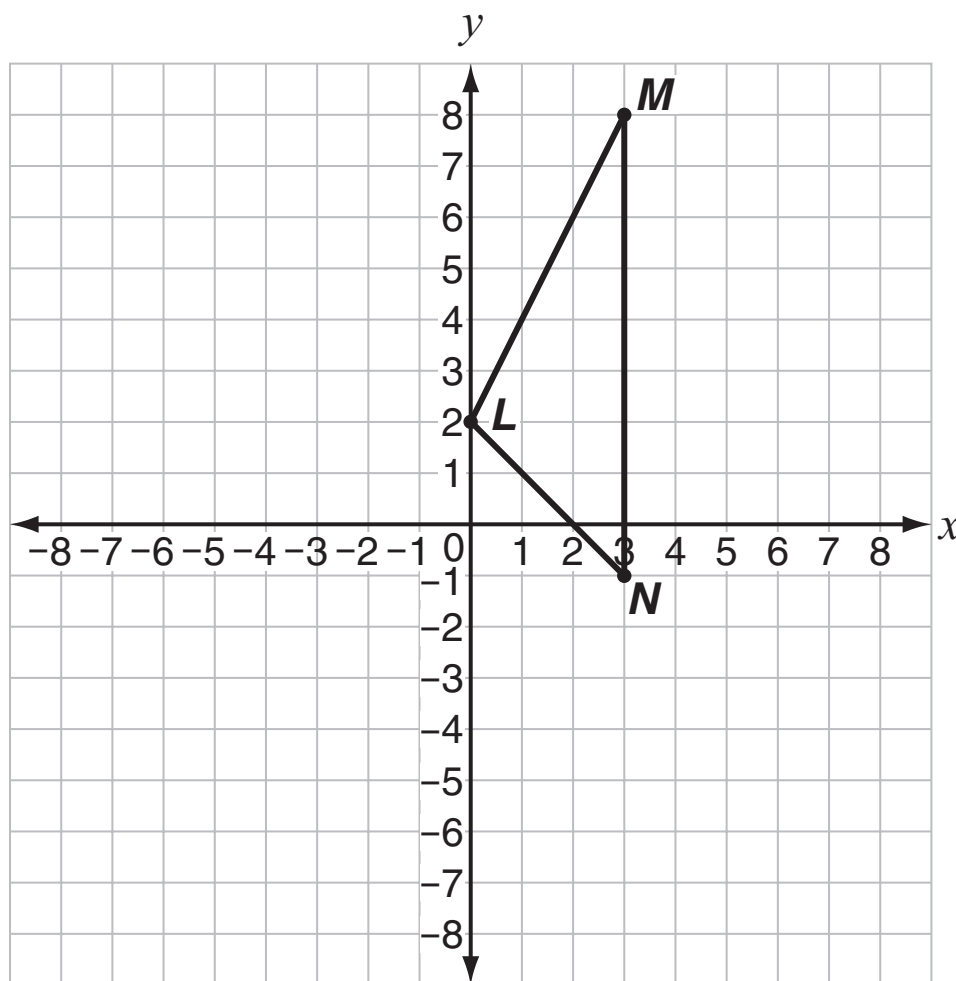

Triangle PQR has these coordinates: $P(0, 2)$, $Q(-3, -4)$, and $R(-3, 5)$.

Which transformation can be used to show that $\triangle LMN$ is congruent to $\triangle PQR$?

- A a reflection across the x -axis
- B a reflection across the y -axis
- C a rotation 180° about point L
- D a rotation 180° about the origin

SESSION

1

- 10.** Erin, Roxby, and Joe went to a farm to purchase some fruit.
- Erin purchased 4.2 pounds of peaches and 1.4 pounds of raspberries for \$14.00.
 - Roxby purchased 2.0 pounds of blueberries and 1.5 pounds of raspberries for \$14.00.
 - Joe purchased only blueberries for \$7.75.

Which additional information would **not** be sufficient to determine how many pounds of blueberries Joe purchased?

- A** the cost per pound of peaches
- B** the cost per pound of raspberries
- C** the cost of 2.1 pounds of peaches and 2.8 pounds of raspberries
- D** the cost of 4.0 pounds of blueberries and 3.0 pounds of raspberries

11. A zoo manager wanted to find out how ticket prices affected the number of tickets he sold. The data he collected is shown in this scatterplot.

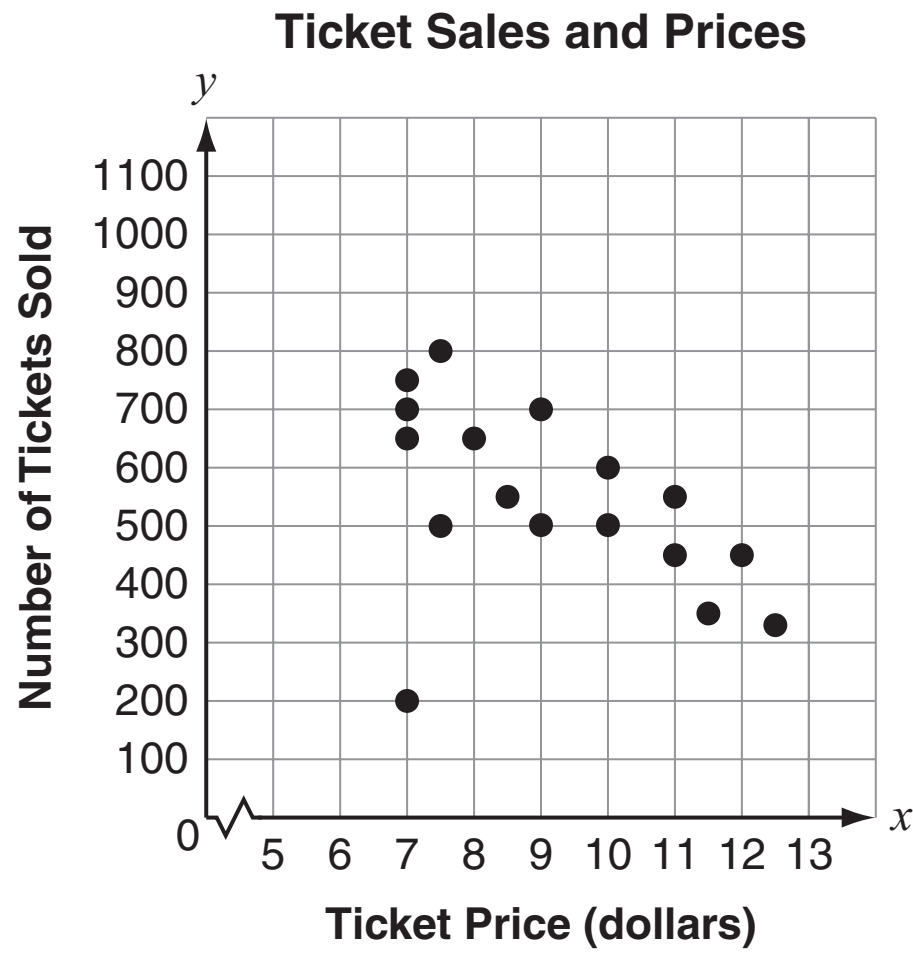

Which equation describes the line of best fit for the data?

- A $y = 50x - 150$
- B $y = -60x + 1,020$
- C $y = -60x + 1,120$
- D $y = -75x + 1,400$



12. Here are descriptions of two functions:

- Function 1: a line that passes through the points listed in this table

x	-3	-1	1	3
y	-14	-8	-2	4

- Function 2: a line that has a slope of 2 and goes through the point (2, 1)

Which statement correctly compares the slopes and y -intercepts of the two functions?

- A Function 1 has a greater slope and a lesser y -intercept than Function 2.
 - B Function 1 has a greater slope and a greater y -intercept than Function 2.
 - C Function 1 has a lesser slope and a lesser y -intercept than Function 2.
 - D Function 1 has a lesser slope and a greater y -intercept than Function 2.
13. Wendi is trying to find this sum.

$$(1.2 \times 10^5) + (2.4 \times 10^4)$$

Which step will **best** help Wendi find the sum, if it is possible?

- A Multiply 4 and 5.
- B Add 1.2 and 2.4.
- C Rewrite 2.4×10^4 as 0.24×10^5 .
- D Since the exponents are different, the sum cannot be determined.

14. Between which two integers does $\sqrt{52}$ fall?
- A 6 and 7
 - B 7 and 8
 - C 8 and 9
 - D 9 and 10

This question has three parts. Be sure to answer all parts of the question.

15. The Jewelry Shop sells bracelets with beads.
- The price of a bracelet that includes one bead is \$5.00.
 - The price of the bracelet increases by 50¢ for each additional bead.
- a. Write an equation that represents the cost of a bracelet, y , as a function of the number of beads, x , on the bracelet.
- b. What do the **slope** and **y-intercept** of the graph of the equation you wrote in part (a) mean with respect to the number of beads and the cost of the bracelet?
- c. What would be the cost, in dollars, of a bracelet with 12 beads? Use words or numbers to justify your answer.

16. Eduardo compares the costs of cashews and pistachios. He uses this graph to model the cost of cashews.

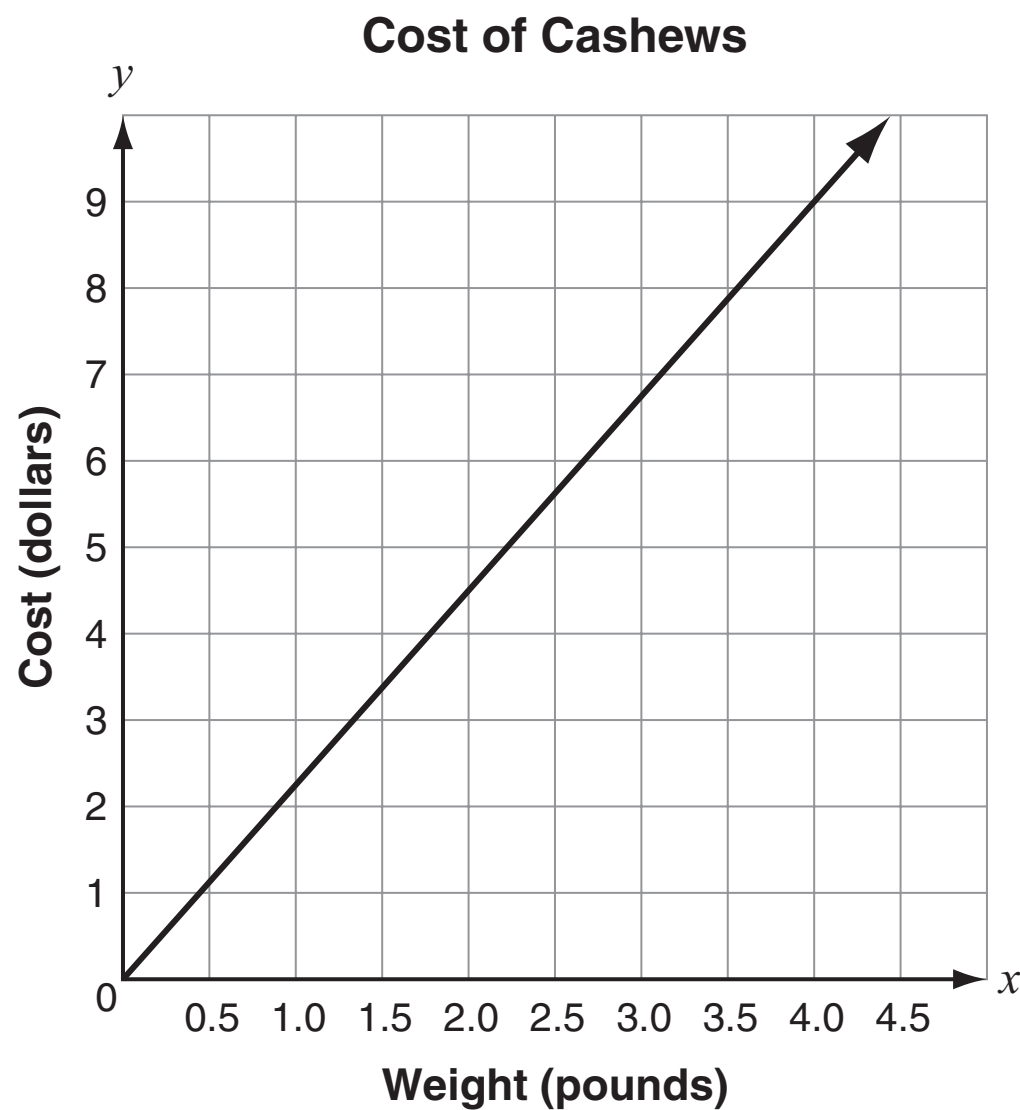

Eduardo uses this equation to model the cost in dollars, c , for p pounds of pistachios.

$$c = 3.25p$$

Based on Eduardo's models, which statement is true about the costs of cashews and pistachios?

- A Cashews cost \$1.00 less per pound than pistachios.
- B Cashews cost \$1.00 more per pound than pistachios.
- C Cashews cost \$2.25 less per pound than pistachios.
- D Cashews cost \$2.25 more per pound than pistachios.

17. A cone has a radius of 5 centimeters and a height of 9 centimeters.

What is the volume, in cubic centimeters, of the cone?

- A** 15π
- B** 75π
- C** 135π
- D** 225π

18. Lou and Kent's teacher wrote a decimal number that repeats.

- Lou thinks the number is an irrational number.
- Kent thinks the number can be written as the quotient of two integers.

Which student is correct?

- A** Only Lou is correct.
- B** Only Kent is correct.
- C** Both Lou and Kent are correct.
- D** Neither Lou nor Kent are correct.

19. An equation is shown.

$$4x - 21 = 12x + 27$$

What value of x makes the equation true?

- A $-\frac{3}{4}$
- B $-\frac{3}{8}$
- C -3
- D -6

20. A graph of a function is shown.

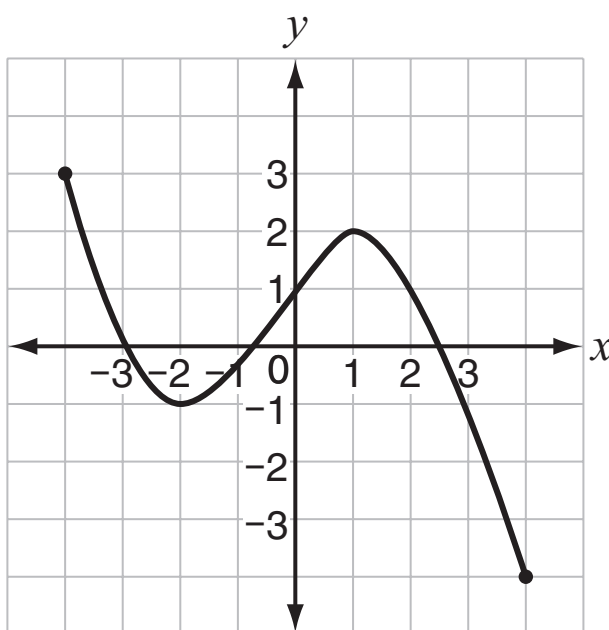

For what values of x is the function increasing?

- A $-2 < x < 1$
- B $-1 < x < 2$
- C $-4 < x < -2$ and $1 < x < 4$
- D $-1 < x < 3$ and $-4 < x < 2$

**No test material
on this page**



**DO NOT
TURN PAGE**

Mathematics Session 2

DIRECTIONS



Today you will take a test in mathematics. For this test, you will answer selected-response and constructed-response questions. Some of the questions may look different from test questions you have seen before, and some may ask about material that is new to you, but it is important to do your best. If you are not sure of the answer to a question, you should still try to answer it.

You **MAY** use a calculator to answer the questions in this session.

- 21.** Dulaney solved a system of equations correctly and ended with the equation $16 = 16$.

Which statement **must** be true about the system of equations Dulaney solved?

- A** There are no solutions to the system of equations.
- B** The solution to the system of equations is $(0, 0)$.
- C** The solution to the system of equations is $(16, 16)$.
- D** There are infinitely many solutions to the system of equations.



22. Quadrilateral $ABCD$ is divided into two right triangles by one of its diagonals, as shown.

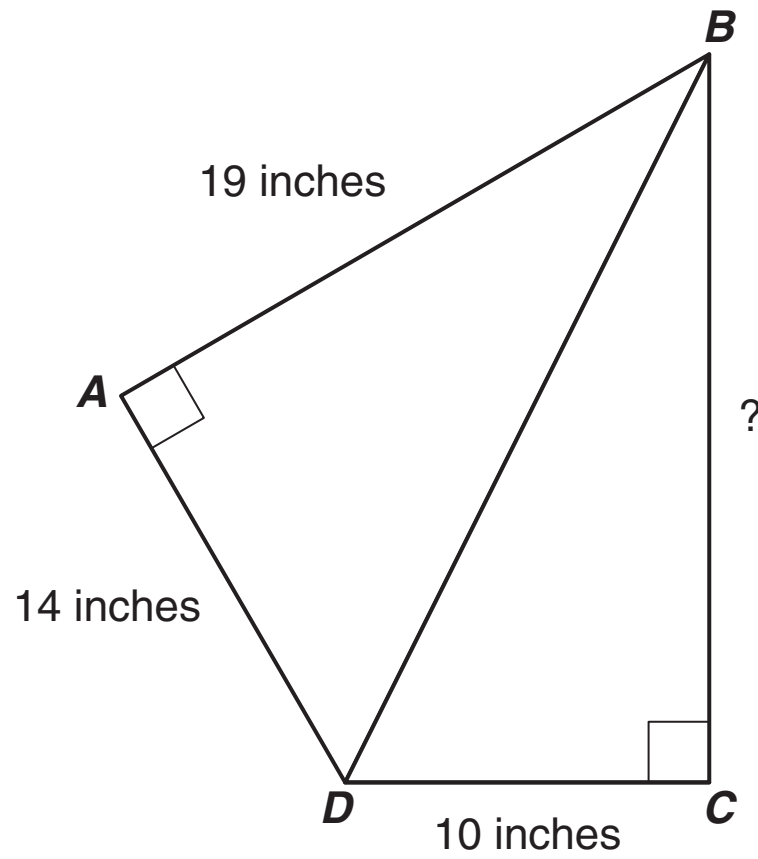

Which is **closest** to the length of side BC ?

- A 16 inches
- B 21 inches
- C 24 inches
- D 26 inches

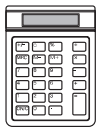

- 23.** The table shows the total cost a telephone company charges its customers for calls.

Long Distance Rates

Length of Call (minutes)	Cost for Call
0	\$0.39
1	\$0.42
2	\$0.45
3	\$0.48
4	\$0.51

Based on the data in the table, what is the cost of a 25-minute long-distance telephone call?

- A** \$12.75
- B** \$9.75
- C** \$1.14
- D** \$0.75

SESSION
2

- 24.** Which equation is true?

A $\frac{3^4 \cdot 3}{3^{-2}} = 3^6$

B $(3^{-2})^{-4} = 3^{-8}$

C $\frac{7^{-4}}{7^{-2}} = 7^{-6}$

D $(4^3 \cdot 4^2)^{-1} = \frac{1}{4^5}$



- 25.** A counselor at Camp Chickadee surveys the campers to find out which morning activity they want to participate in. The results are shown in the table.

Survey Results

	Archery	Kayaking
Girls	96	54
Boys	79	72

What percentage of girls choose kayaking?

- A** 18%
- B** 36%
- C** 43%
- D** 75%

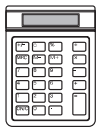

26. Which table represents a function that is **not** linear?

A

x	y
-1	-18
0	-9
2	9
3	18

B

x	y
-1	-9
0	0
2	18
3	27

C

x	y
-1	10
0	9
2	7
3	6

D

x	y
-1	1
0	0
2	4
3	9



27. Triangle JKL is similar to triangle QSR , as shown.

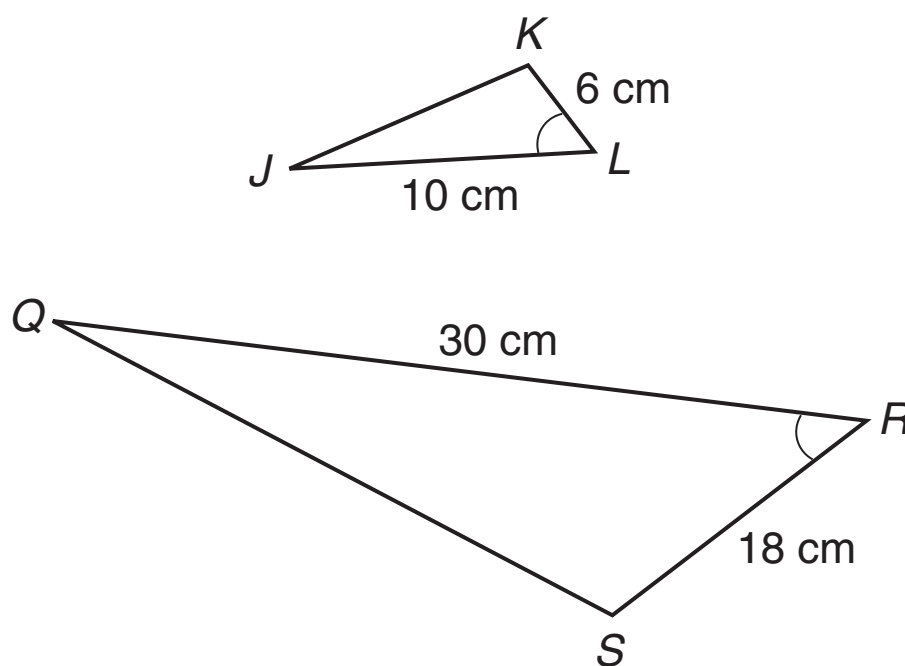

Which statement is **not** true?

- A The length of line segment QS is three times the length of line segment JK .
- B The length of line segment KL is one-third the length of line segment SR .
- C The measure of angle Q is three times the measure of angle J .
- D The measure of angle L is equal to the measure of angle R .

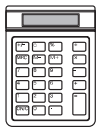

This question has two parts. Be sure to answer all parts of the question.

- 28.** Points P , Q , R , and S are vertices of a right rectangular prism as shown. The length of \overline{QR} is 5 centimeters and the length of \overline{QS} is 5 centimeters.

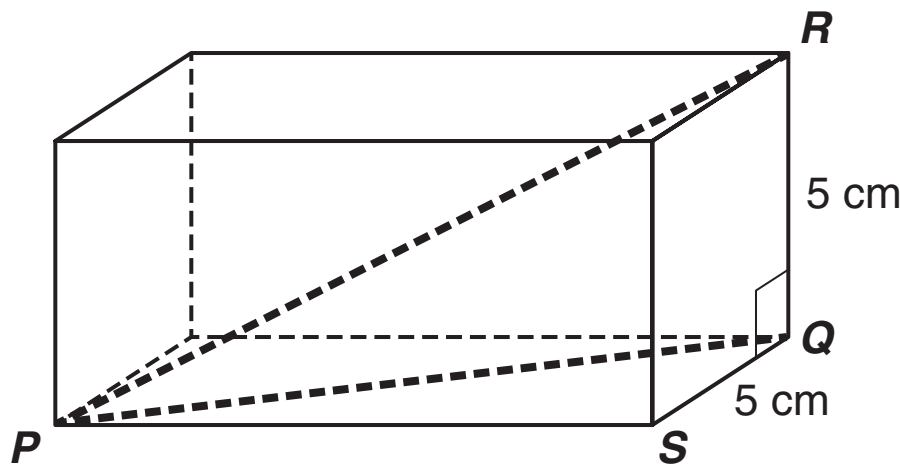

The length of \overline{PS} is two more than three times the length of \overline{QS} .

- Write an expression to represent the length of \overline{PQ} .
 - What is the estimated length, in centimeters, of \overline{PR} ? Show your work or explain how you know.
- 29.** Light travels at an approximate speed of 3×10^8 meters per second. The distance from Earth to the Sun is approximately 1.5×10^{11} meters.
- Which is the **best** estimate for the number of seconds it takes light to travel from the Sun to Earth?
- 200 seconds
 - 500 seconds
 - 2,000 seconds
 - 5,000 seconds



30. This table shows the relationship between x and y in a function.

x	y
-3	11
-1	7
1	3
3	-1

Which equation represents all the data in the table?

A $y = 4x + 1$

B $y = -x + 2$

C $y = \frac{1}{2}x + 4$

D $y = -2x + 5$

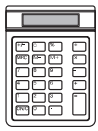

Use the information below to answer questions 31 and 32.

The relationship between the outside high temperature, in degrees Fahrenheit, and the number of people who went to ice-skate at the Mall Rink for 20 random days throughout the year is shown in this scatterplot.

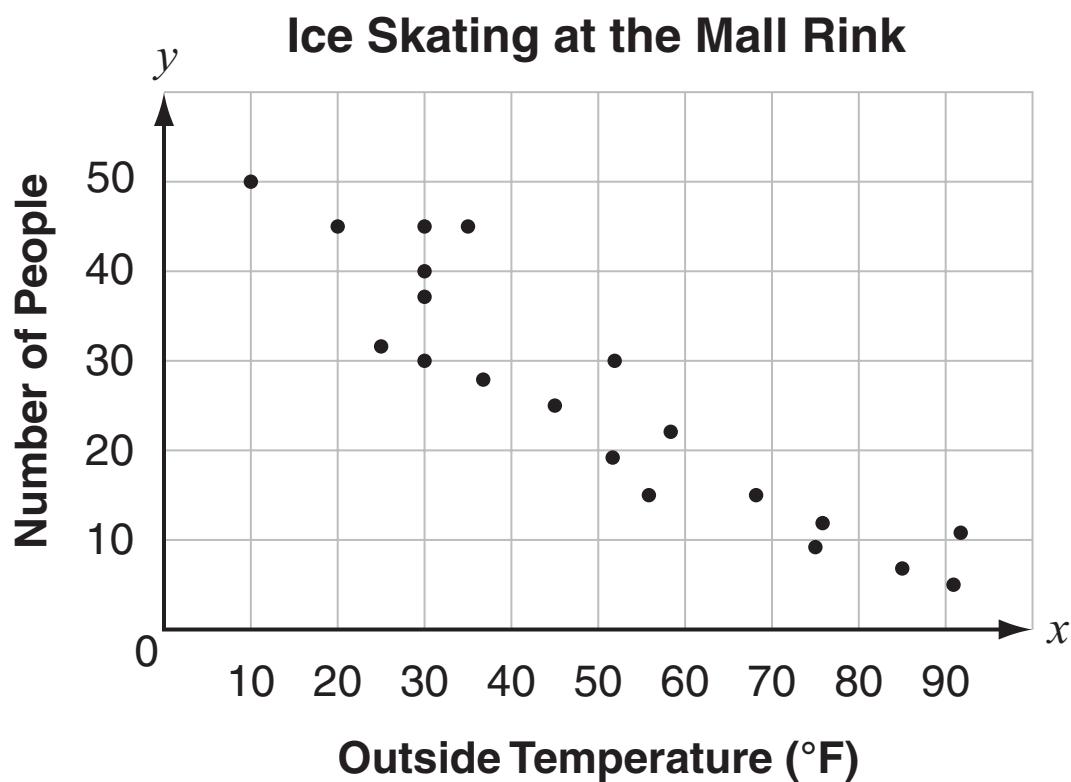

31. Jordan was asked to analyze the scatterplot to see if there are any outliers in the data. Which feature should Jordan look for that would indicate an outlier?

- A** data points that are identical
- B** data points that are the farthest left and the farthest right
- C** a data point that is far removed from the basic pattern of the other data points
- D** a data point that is on the direct line from the farthest left point and the farthest right point



32. Four students were asked to analyze the 20 data points on the scatterplot and predict the number of people who would go to the mall to ice-skate one morning if the outside high temperature was 40°F . Each student's prediction and reasoning are listed:

- Brenda: 45, since that is the number of people who went to the mall to ice-skate the most often
- Franklin: 35, since that is the average of the greatest and least number of people in the interval from 30°F to 50°F
- Thera: 28, since that is the average number of people for the data points on either side of 40°F
- Zachary: 32, since the line of best fit would have an approximate equation of $y = -0.5x + 52$ and $-0.5(40) + 52 \approx 32$

Which student **best** analyzed the scatterplot to predict the number of people who would go to the mall to ice-skate if the outside high temperature was 40°F ?

- A** Brenda
- B** Franklin
- C** Thera
- D** Zachary



33. Which of these tables shows the inputs and outputs of a function?

A

x	4	5	7	-10
y	6	6	6	-6

B

x	4	4	4	4
y	5	6	7	8

C

x	4	4	5	5
y	2	6	2	6

D

x	-3	-3	3	3
y	2	4	2	4



34. Triangle EFG is reflected across the x -axis and dilated by a scale factor of $\frac{1}{2}$ about the origin to form triangle $E'F'G'$.

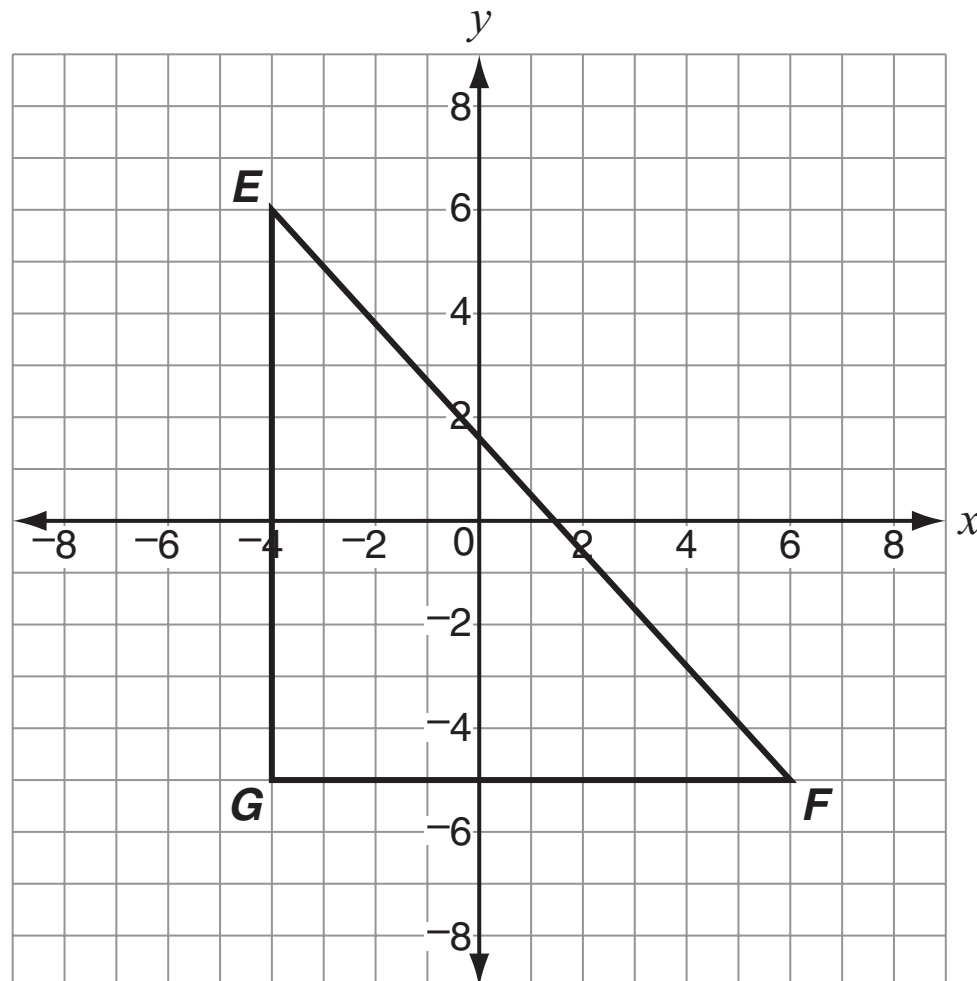

Which ordered pair describes the location of vertex E' ?

- A (2, 3)
- B (-2, -3)
- C (8, 12)
- D (-8, -12)

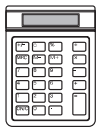

This question has three parts. Be sure to answer all parts of the question.

- 35.** At a music festival, there is one price for adult tickets, one price for child tickets, and one price for senior citizen tickets.
- The Hernandez family bought 3 adult tickets and 2 child tickets for a total of \$180.
 - The Carr family bought 1 adult ticket and 2 child tickets for a total of \$100.
- a. Write a system of equations that can be used to find the price of each adult ticket and the price of each child ticket. Be sure to use variables to represent each type of ticket in your system of equations.
- b. What is the price, in dollars, for each adult and each child ticket? Show your work or explain how you know.

The Gupta family bought 2 adult tickets, 4 child tickets, and 1 senior citizen ticket for a total of \$235.

- c. What is the price, in dollars, for each senior citizen ticket? Show your work or explain how you know.

- 36.** Daniel wants to know if people prefer to watch movies in a theater or at home. He randomly surveyed 200 students and adults. The results of his survey are shown in this table.

	In Theater	At Home	Total
Students	50	30	80
Adults	36	84	120
Total	86	114	200

Based on the data in the table, which statement is true?

- A** Of the total people surveyed, 80% were students.
- B** Of the adults surveyed, 70% prefer to watch movies at home.
- C** Of the students surveyed, 30% prefer to watch movies at home.
- D** Of the total people surveyed, 50% prefer to watch movies in a theater.



- 37.** Which dimensions describe a cylinder with a volume of 250π cubic inches?
- A** radius = 5 inches; height = 10 inches
 - B** radius = 10 inches; height = 5 inches
 - C** radius = 10 inches; height = 25 inches
 - D** radius = 25 inches; height = 10 inches

- 38.** A car is moving at a constant speed. It slows down and stops at a traffic light, then speeds up and moves at a constant speed.

Which graph **best** represents the situation?

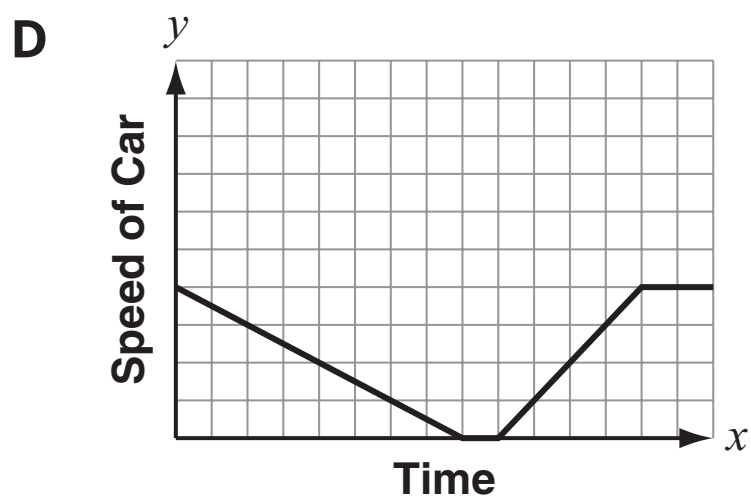
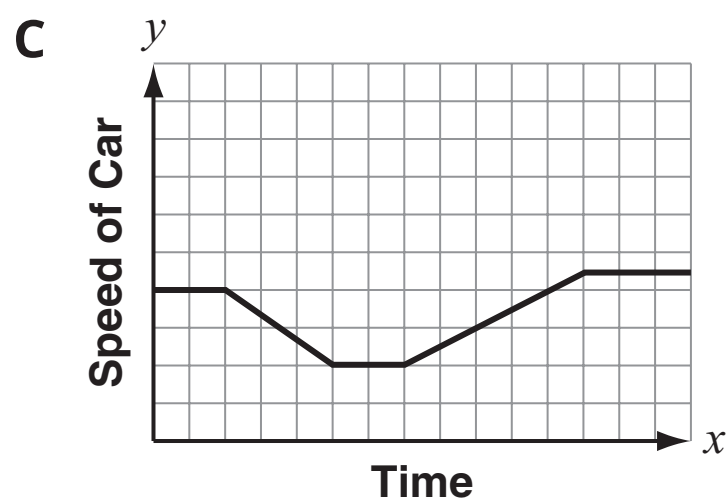
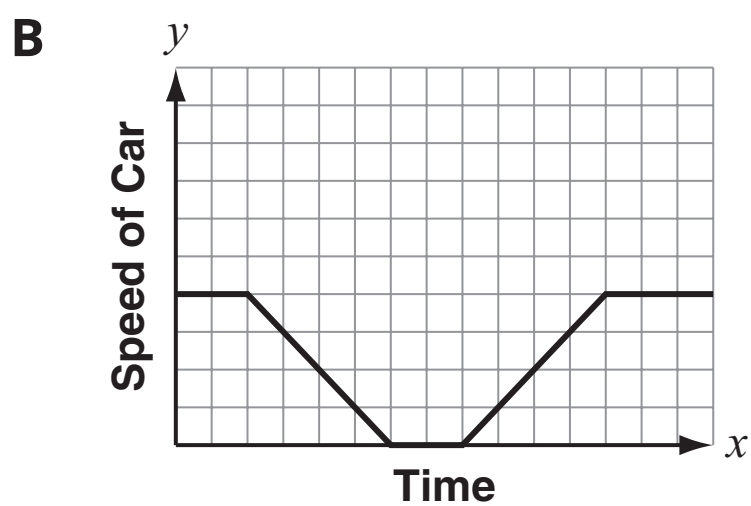
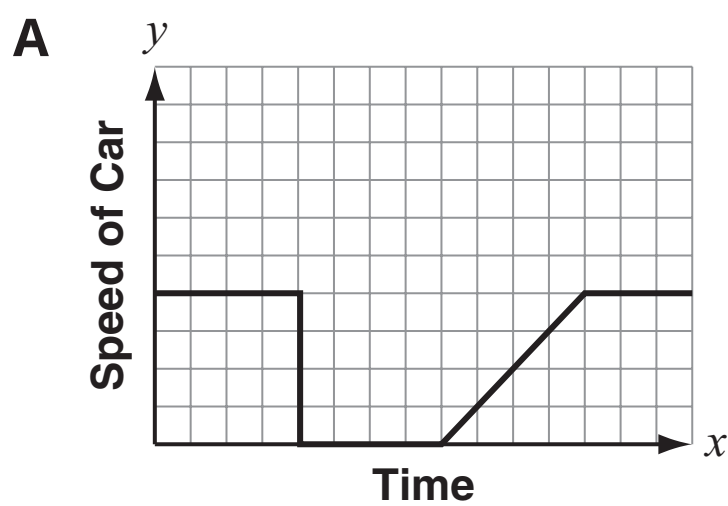

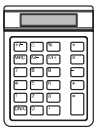

39. Similar triangles ABC and CDE are shown on a coordinate plane. Line m passes through the points A , C , and E .

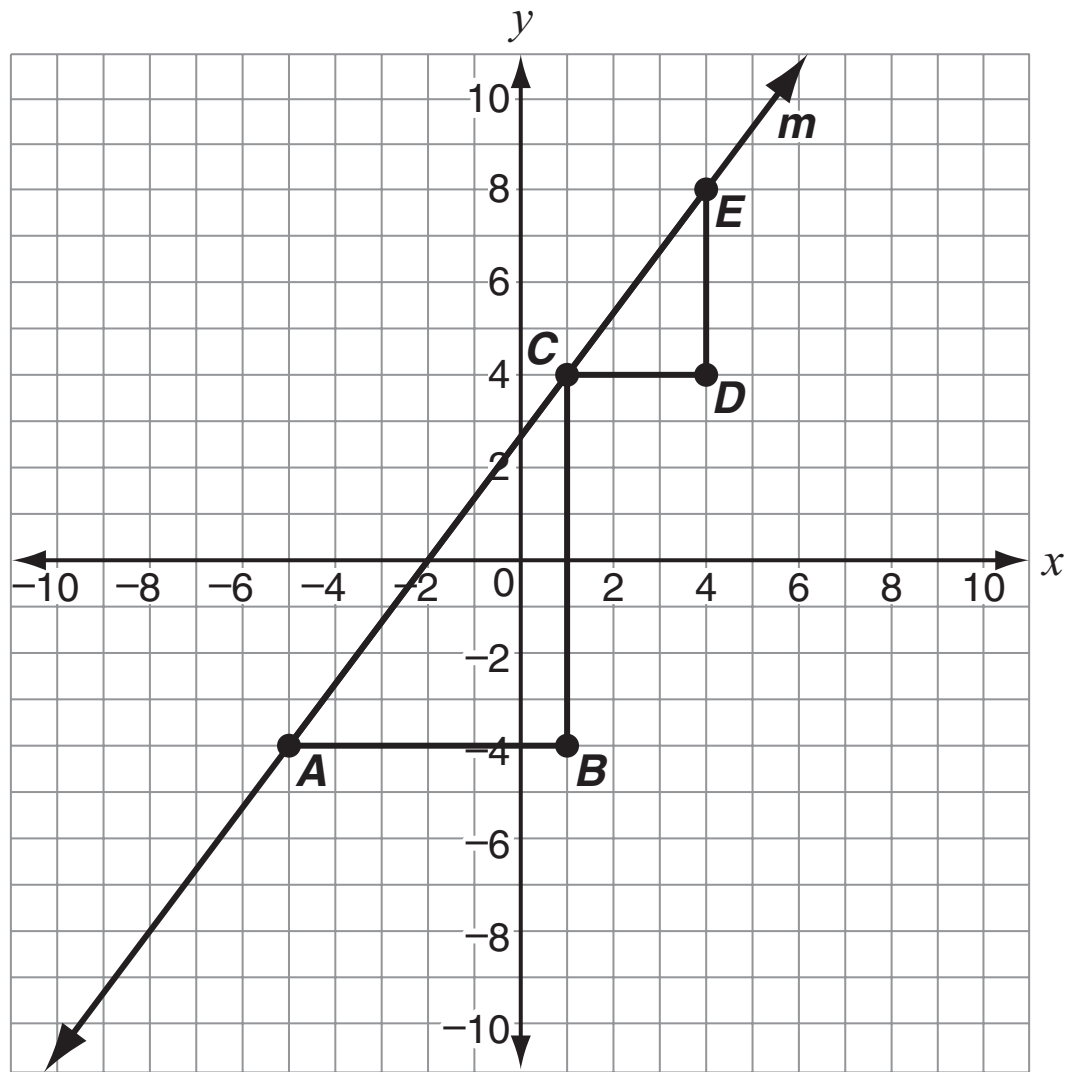

Which statement about triangles ABC and CDE is true?

- A $AB = CD$
- B $BC = DE$
- C The slope of \overline{AC} is the same as the slope of \overline{CE} .
- D The slope of \overline{AC} is greater than the slope of \overline{CE} .



- 40.** A 6-foot ladder is leaning against a wall. The bottom of the ladder is 4 feet from the wall, as shown.

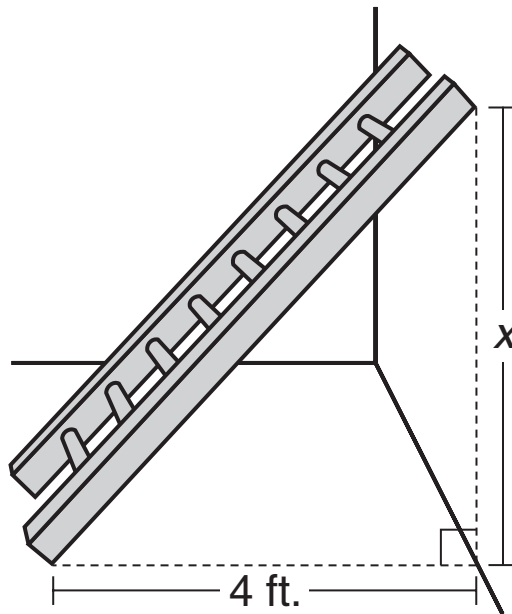

Which length is closest to x , the distance from the floor to where the ladder touches the wall?

- A** 2 ft.
- B** 4 ft.
- C** $\sqrt{20}$ ft.
- D** $\sqrt{52}$ ft.

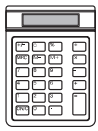

41. This scatterplot shows the relationship between the number of minutes students read a certain book one night and the number of pages read.

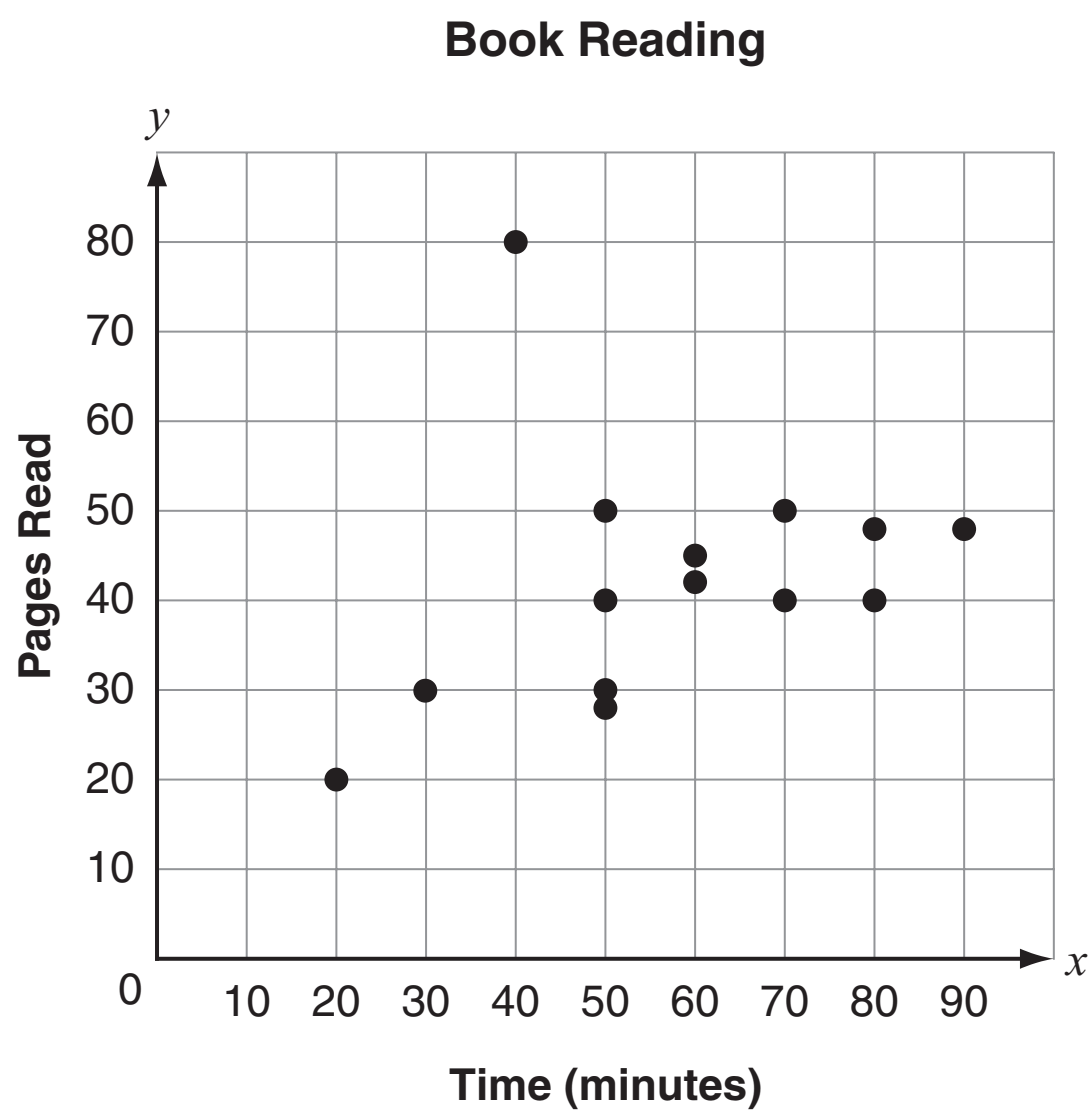

Which ordered pair can **best** be described as an outlier?

- A (20, 20)
- B (40, 80)
- C (50, 50)
- D (90, 48)





**DO NOT
TURN PAGE**



**NEW MEXICO MEASURES
OF STUDENT SUCCESS AND
ACHIEVEMENT**

16 Digit Static Barcode